

# BAHAMA®

Jumbrella



## The Heart of it All

Jumbrella is the solution for everything. Together with Jumbrella outSide it can be found in our product range between »small and light« like the model Pure and »large« like the models Jumbrella XL, Largo & Magnum. The large-size parasol Jumbrella stands out with its numerous possible combinations and additional features. The different features can be individually combined depending on your technical requirements.

- \* 28 different model sizes from 4,5 m<sup>2</sup> to 36 m<sup>2</sup> and side lengths from 1,5 to 6 m
- \* Round, square and rectangular models
- \* Great variety of additional features e.g. textile gutters, side panels, lighting with LED, heating, speakers, TV, Wifi, extra protection with the V4A | Maritime Edition
- \* Maintenance-free servo mechanism for trouble-free opening and closing
- \* Energy efficient handling through gradual opening (servo-mechanism); depending on model 2- or 4-stages
- \* No loose functional parts like ropes, cranks or connectors
- \* 2 lockable handles with spring buckles for optimal fabric tension
- \* Standard frame in traffic white | RAL 9016, textured matte finish or in anthracite grey | RAL 7016, textured matte finish
- \* Optional custom design of frame finish (color, fancy designs such as wood look | Golden Oak) and of membranes
- \* Perfect, lasting tension as the textile membrane is integrated into the spoke
- \* Additional, stabilizing support spokes
- \* Membranes in three different high-quality fabrics
- \* Large, contemporary selection of colors; uni-colored or striped
- \* Excellent UV-protection UPF 50+
- \* Absolutely waterproof
- \* Numerous possibilities for printing on the textile membranes and/or valances
- \* Including protective cover with lacing, made of tent fabric | Nicotarp
- \* Short delivery times, fast spare parts delivery, exceptionally long spare parts supply
- \* Various installation options as well as adaptations for various on-site conditions (either fixed or tiltable)
- \* Newest generation of infrared radiators that can remain in the closed parasol
- \* Integrated theft prevention
- \* Up to 111-months wind warranty depending on installation options and parasol size of up to wind force 10 | 102 km/h

## Bahama

Founded in 1950 today Bahama designs and manufactures a great variety of high-quality large-size parasols and sun sails. National and International customers alike trust in our industrial technology and accurate workmanship. The premium products from Bahama characteristically stand for technical attributes like compactness, durability and wind stability but also for aesthetical features like beautiful designs and materials.

»Made in Germany« – our full range production facility manufactures nearly all parts in house. Bahama further processes sustainable and environmentally friendly materials according to the OEKO-TEX 100 standard, Class 1. The combination of high-quality materials and the structural features allows Bahama to guarantee wind stability for its products, depending on the model, of up to 130 km/h.

**And most importantly:** we love customer service – from consulting to installation, from cleaning to winter storage and maintenance.

**Discover the possibilities of an extended outdoor season. No matter what the weather. Just get to know us!**



reddot design award  
winner 2018



The Jumbrella 4 × 4 m wins the iF DESIGN AWARD 2018, the Red Dot Award 2018 and the German Design Award 2019. All awards, which are among the most acclaimed prizes for great designs since the 1950s, will be handed out separately. The independent international jury of experts awarded the coveted quality label among more than 6,000 submissions from over 50 countries.

Note: Subject to change without notice.

# BAHAMA®



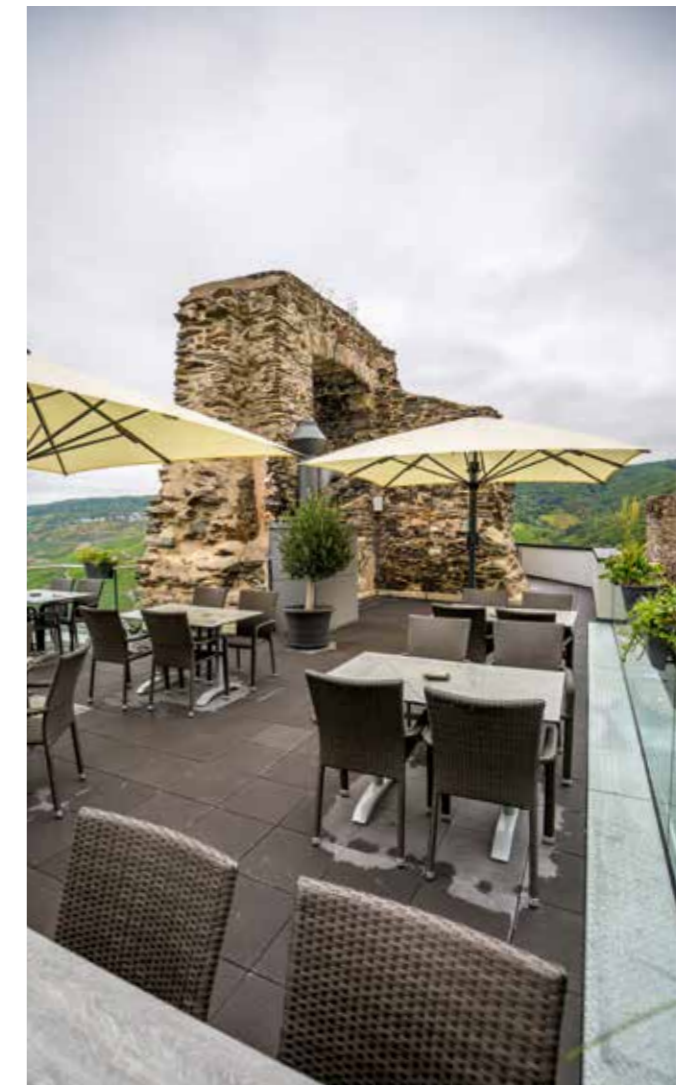



copyright © Ian Volvem





reddot design award  
winner 2018

Preisverleihung in der Zeche Zollverein Essen | UNESCO-Welterbe | Designer's Night 2018 im Red Dot Design Museum



copyright © Van Volxem



# Product Information

## 1 Textile Membranes

No matter your choice of fabric, the resulting textile membranes combine all the attributes of a durable and sustainable product. These include next to the high-quality appearance numerous technical functions.

### 1.1. Brand Name: betex®05 | Fabric exclusively crafted for Bahama

100% polyester fabric with top transparent coating

Grammage of approx. 200 g/m<sup>2</sup>

Excellent UV-protection UPF 50+ protects against UV radiation (exception: snow 9577)

High degree of fabric lightfastness (i.e. fading) (DIN EN ISO 105-B02 Class ≥ 6-7)

High waterproofness, pressure resistance (DIN EN 20811, ISO 811 | Water column ≥ 100 mbar, 1.000 mm)

Low moisture absorption, dries quickly

High temperature resistance (DIN 53361 from -30°/+90°C)

Excellent friction resistance (DIN EN ISO 105-x12 | Class ≥ 4-5)

High tear resistance due to high thread count

Durable, tailor-made and dimensionally stable with perfect membrane tension

Sustainable and environmentally friendly fabrics with the OEKO-TEX 100 Standard, Class 1

Exchangeable and washable one-piece membranes

Numerous contemporary colors (custom colors upon request)

Printable with the most modern printing process



### 1.2. Brand Name: Precontraint 302

PVC coated Polyester 550 Dtex.  
SERGE FERRARI PRECONTRAIT® coating technology

Grammage of approx. 480 g/m<sup>2</sup>

Excellent UV-protection UPF 50+ protects against harmful UV radiation

Highest degree of fabric lightfastness (i.e. fading) (DIN EN ISO 105-B02 | Class ≥ 7-8)

Heat-sealed segments, 100% waterproof

High temperature resistance (DIN 53361 from -30°/+70°C)

Fire retardant (DIN 4102-B1)

Exceptional surface stability and tear resistance

Durable, robust, dirt-repellant and stable in all weather conditions

Own cleaning possibility due to increased dirt accumulation through leaves, tree sap, bird-droppings, car exhaust or dust

Recyclable

Numerous contemporary colors (custom colors upon request)

Printable with the most modern printing process



### 1.3. Brand Name: swela elegance uni-colored and striped | ZebraS

100% polyester fabric with dirt and water repelling impregnation

Grammage of approx. 310 g/m<sup>2</sup>

Excellent UV-protection UPF 50+ protects against harmful UV radiation

Highest degree of fabric lightfastness (i.e. fading) (DIN EN ISO 105-B02 | Class ≥ 7-8)\*

High waterproofness, pressure resistance (EN 20811, ISO 811 | Water column ≥ 35 m bar, 350 mm)

Weather fastness (DIN EN ISO 105-B04 | Class ≥ 7-8)\*

Excellent friction resistance (DIN EN ISO 105-x12 | Class ≥ 4-5)

High tear resistance

Distinctive surface feel

Not printable

Model-related minimum order quantity

\* Exception ZebraS: Highest degree of fabric lightfastness (Class ≥ 4-5/grey) and weather fastness (Class ≥ 4-5/grey)



# Product Information



## 2 Umbrella Frame

The difference may not be obvious at first sight: but the large-size parasols from Bahama have an inner and an outer pole that optically come together to form one center pole. Better sturdiness also means better stability and the corresponding safety.

### Center pole with Outer and Inner pole

Easy and quick opening and closing due to the maintenance-free servo-mechanism

Tension latches with spring buckles for opening and closing instead of a crank, easy and efficient handling **2.1**

Extra stability through extruded, internally strengthened and profiled aluminum center pole **2.5**

Pole diameter approx. 80 mm, wall thickness approx. 2.5 mm

Impact and scratch resistant due to PES powder-coated center pole, post-baked

Standard frame in traffic white | RAL 9016, textured matte finish or in anthracite grey | RAL 7016, textured matte finish **2.1**

Optional custom design for frames (color, exclusive wood look | Golden Oak **2.2**, concrete look **2.3**, corten steel look **2.4**, resin parts in black, certain components in anthracite grey | RAL 7016, textured matte finish)

Cylindrical locks in the handles prevent unauthorized opening and closing **2.1**

### OPTIONAL

Umbrella center pole extension, up to 50 cm are possible depending on model

Umbrella center pole reduction (upon request)

### Spokes, Support Spokes, Bearings and Hinges

The quality of a parasol can only be as good as its supporting and connecting parts.

Rectangular and hollow extruded aluminum profile with special alloy Al F30 / 32 (no sharp edges)

Mounted using stainless steel axle bolts and spring pins **2.6**

No plastic parts used

With hollow seam for spoke membrane integration

Individually exchangeable spokes and support spokes

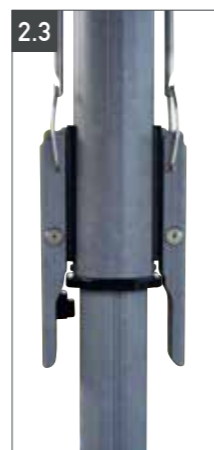

## 3 Installation Options

There is a choice of mobile or permanent installation options. Mobile installation is characterized by a greater degree of flexibility. When installing an in-ground option, building measures must be carried out. All installation options are hot-dip galvanized and powder coated in traffic white | RAL 9016, textured matte finish or in anthracite grey | RAL 7016, textured matte finish. For exceptions refer to the individual descriptions.

### 3.1. Mobile Installation Options

#### I. Concrete Stand

Made of shapely exposed concrete, chamfered edges

For parasols with/without electro-mechanical features

With forklift slot

Connecting components with tilting hinge, powder-coated in RAL color of parasol frame

Size of concrete stand: approx. 800 x 800 x 250 mm, weight approx. 310 kg (umbrella 250 mm higher)

With wind warranty (mobile) for umbrellas with up to 4.5 m edge length or diameter



#### II. Cross-Frame

Steel frame for 8, 12 or 16 standard flagstones 500 x 500 x 50 mm (not included in the supply scope) (depending on variant, umbrella 28-352 mm higher)

Weight of steel frame: approx. 28 kg for 8 flagstones, approx. 30 kg for 12 flagstones, approx. 60 kg for 16 flagstones

Steel, galvanized

Steel frame for 16 flagstones **III.1** with tiltable connecting components, powder-coated in RAL color of parasol frame

Wind warranty (mobile) valid only when using the specified flagstones

### OPTIONAL

Powder-coating in RAL color of parasol frame

Height adjustable in all 4 corners, required for umbrellas with electro-mechanical options (included for 16 flagstones)

Standard flagstones 500 x 500 x 50 mm

Sizes of cross-frames for picture II.

for  $\varnothing 3$  |  $\varnothing 3.5$  |  $\varnothing 4$  |  $\varnothing 4.5$  |  $3 \times 1.5$  |  $3 \times 3$  |  $3.5 \times 3.0$  |  $3.5 \times 3.5$  |  $4 \times 2$  |  $4 \times 3$  |  $4 \times 3.5$  |  $4 \times 4$  |  $4.5 \times 3$  |  $4.5 \times 3.5$  |  $4.5 \times 4.0$  steel frame for 8 standard flagstones, size 1130 x 1130 mm, weight approx. 260 kg

for  $\varnothing 5$  |  $\varnothing 5.6$  |  $4.5 \times 4.5$  |  $5 \times 2.5$  |  $5 \times 3$  |  $5 \times 5$  |  $5 \times 3.75$  |  $5 \times 4$  |  $6 \times 3$  steel frame for 12 standard flagstones, size 1130 x 1130 mm, weight approx. 375 kg

for  $\varnothing 6.3$  |  $\varnothing 7$  |  $6 \times 4$  |  $6 \times 4.5$  steel frame for 16 standard flagstones, size 1200 x 1200 mm, weight approx. 520 kg

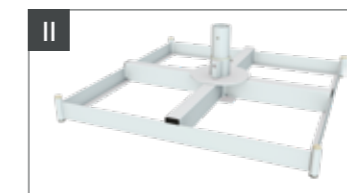

Sizes of the Steel Plate Bases for picture III. and III.1

for  $\varnothing 3$  |  $\varnothing 3.5$  |  $\varnothing 4$  |  $\varnothing 4.5$  |  $3 \times 1.5$  |  $3 \times 3$  |  $3.5 \times 3.0$  |  $3.5 \times 3.5$  |  $4 \times 2$  |  $4 \times 3$  |  $4 \times 3.5$  |  $4 \times 4$  |  $4.5 \times 3$  |  $4.5 \times 3.5$  |  $4.5 \times 4.0$  2 layers, 8 plates, 490 x 490 x 15 mm, approx. 240 kg

for  $\varnothing 5$  |  $4.5 \times 4.5$  |  $5 \times 2.5$  |  $5 \times 3$  1 layer, 4 plates, 740 x 740 x 15 mm, approx. 290 kg

for  $\varnothing 5.6$  |  $\varnothing 6.3$  |  $\varnothing 7$  |  $5 \times 5$  |  $5 \times 3.75$  |  $5 \times 4$  |  $6 \times 3$  |  $6 \times 4$  |  $6 \times 4.5$  2 layers, 8 plates, 740 x 740 x 15 mm, approx. 550 kg

### III. Steel Plate Base with 4 or 8 Steel Plates | 2 Layers

Flat construction with only 15 mm installation height; no tripping hazard

Tiltable screw-on receiving column

Plate size: 490 x 490 x 15 mm (ea. 28 kg) or 740 x 740 x 15 mm (ea. 65.2 kg)

### OPTIONAL

Powder-coating in traffic white | RAL 9016, textured matte finish or in anthracite grey | RAL 7016, textured matte finish in **III.1** and/or in RAL color of the parasol frame

Spacer (e.g. for terrace substructures), starting at 89 mm **III.2**; possibly required for umbrellas equipped with electromechanical options, measurements don't include the steel plate height nor the 8 mm thick winter cover, which has to be taken into consideration for flush-mounting





# Product Information



## 3 Installation Options

### 3.2. Permanent Installation Options

#### I. In-Ground Sleeve

Sleeve to be set in concrete

Powder-coated above-ground connecting components

Weight: approx. 6 kg

For parasols with **I.1** /without **I.2** electro-mechanical features



#### II. In-Ground Tipping Base

Lower part to be set in concrete

Powder-coated above-ground connecting components with tilting hinge

Powder-coated center pole sleeve

Weight: approx. 4.8 kg

For parasols with **II.1** /without **II.2** electro-mechanical features

#### OPTIONAL

Spacer for Tipping Base for bridging a gap e.g. an installation in a kindergarten sandbox; height orderbased starting at min. 89 mm to 392 mm **II.3** (special sizes on request)

The 8 mm thick winter cover has to be taken into consideration for flush-mounting

Also available for umbrellas with electromechanical options



#### III. Octagonal Surface Mount with Counter-Bores

Weight: approx. 18 kg

Powder-coating in RAL color of parasol frame

Connecting components with tilting hinge **III.1**

Especially suited for bolting onto massive concrete surface

#### OPTIONAL

Receiving column is welded on to surface mount

»fischer« heavy-duty anchoring bolts (1 set =8 pcs.); type #FH II 15/15 SK A4; M10 thread; incl. concrete drill type #SDS Plus II, drill depth 105 mm and Allen wrench SW 6



#### IV. Dual Mounting Console (order-related)

Octagonal surface mount with spacer and tiltable connecting components

Height: starting at 89 mm - max. 392 mm (custom sizes upon request). The 8 mm thick winter cover has to be taken into consideration for flush-mounting

Weight: approx. 24 kg

With integrated theft prevention and winter cover plate

#### OPTIONAL

Also available for umbrellas with electromechanical options

Also available with welded spacer and non-tiltable connecting components of the in-ground sleeve



#### V. Multi-use flange plate | for 3 or 4 screws

dimensions for 3 screws: 208,5 x 194 x 20 mm **V.1**

dimensions for 4 screws: 238,5 x 224 x 20 mm **V.2**

Weight: approx. 9.7 kg

(includes the winter cover)

Galvanized multi-use flange plate | adaption for In-Ground Tipping Base **V**

For in-ground bases with 3 or 4 screws, with M10 or M12 screw connection

incl. winter cover

Galvanized multi-use flange plate (20 mm) with stainless steel lid (3 mm) **V.1**

Connecting components not included in the supply scope



#### VI. Connecting Plate for »Krinner« Ground Screw

Suitable for »Krinner« KSF F 140x1600-M no setting in concrete, screw-in foundation **VI.1**

Galvanized steel

Weight: approx. 6 kg

For tiltable connecting components used for Tipping Base

Height adjustable

Incl. screws for fastening and leveling on Krinner Ground Screw

With cover plate

#### OPTIONAL

Spacer also available **II.3**

Connecting components not included in the supply scope



# Product Information



## 4 Transport Packaging

The parasols leave our production facility in perfect condition. To ensure they arrive in perfect condition they are delivered in a hard-cardboard cylinder tube.

Outer diameter: approx. 410 to 462 mm\*

Cylinder length: approx. 3.600 to 4.180 mm\*

Weight without parasol: approx. 20–30 kg\*

\*depending on model



# Additional Features



## 1 Valance

The valance is hemmed, dyed in the matching color and the edgelines are thermally processed. No ruffles here.

Valance height approx. 30 cm

Continuous or split valance possible

Additional advertising space



## 2 Printing

The Bahama UV printer uses 9 color channels. Even pure white. Only lightfast and highest quality inks are used to ensure color accurate fonts, logos and emblems are positioned with millimeter precision. The membrane segments are sewed together after printing; the PVC-coated segments are heat sealed together.

No fading due to highly UV-resistant colors

Optimal advertising impact

Individual printing of the textile membranes

**References:** Mc Donalds, Starbucks, Heineken, Carlsberg, Bitburger, Gaffel, Café & Bar Celona, Café Extrablatt, Hilton, Kempinski et al

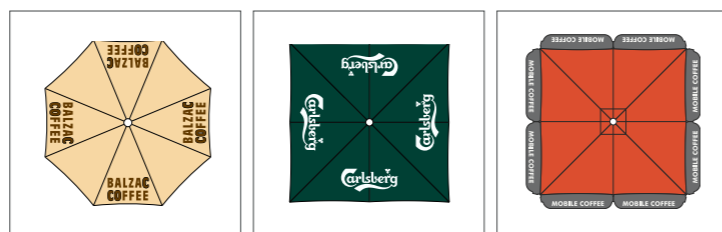

## 3 Extra Protection V4A | Maritime Edition

Optional off-shore stainless steel version »maritime«. Cannot be retrofitted.

All metal components made of a special alloy V4A stainless steel

Developed for use near the seaside

Especially durable

## 4 Textile Gutters

Not only rain falls from the sky, bird droppings or wet leaves are often bothersome, too. To attain one entirely closed area the individual parasols can be connected by a textile gutter creating a coherent covering that is optically appealing.

Gutter with a gradient for water runoff

Fastening with carabiners and chains

Stability due to rods inserted into the hollow seams

Colors matching the textile membrane

Optically appealing unit of parasol and gutter

Light-permeable for a cozy atmosphere

High waterproofness

Protection against rain, bird droppings and leaves

Variable mounting with threaded eye screws and slot nuts on spoke profile

Weight model-related (from 4.5 m side length)



## 5 Protective Cover

Not only does it keep everything together, it also keeps it clean. Film packaging is often not enough protection. To this end there are – especially for winter or longterm storage – robust protective covers in different versions.

### Protective Cover basic

Light weather protection cover **5.1**

Tent fabric | Nicotarp with lacing

Included with the delivery of a new parasol; not included when ordering the Protective Cover – comfort

### Protective Cover comfort

Robust weather protection cover

betex®05« | Polyester | 9801 - concrete

With zipper for telescopic rod

### Protective Cover comfort with Telescopic Rod

Equipped with a telescopic rod **5.2**. When ordering more than one cover, only one telescopic rod is necessary

Easy to put over the parasol

Recommended for rectangular models

## Choice of Fabrics

betex®05, Preconstraint 302, swela elegance

## OPTIONAL

Also available as self-supporting edition



# Additional Features



## 6 Side Panels

There is no more tossing a coin to figure out who has to sit at the edge of the parasol when the weather isn't behaving. The quickly and easily unrolled »side panels« not only protect you from sudden rain showers, but also against the cold and wind. Through this possibility of creating a boundary, they provide a feeling of secure comfort.

Made completely of textile fabric with or without flexible windows of 0.5 mm strong Polyglass **6**

Variable mounting with threaded eye screws and slot nuts on spoke profile (no additional drill hole) With zipper for opening and closing **6.1**

High waterproofness

Stability due to rods inserted into the hollow seams

Drip edge on the ground made of PVC-coated fabric, Preconstraint 705-1070 **6.2**

Quick and easy to use; just hook it in

Light-permeable for a cozy atmosphere

Protection against sun, rain, wind and the cold

Temporary room solutions for individual event e.g. weddings, street parties, company festivities or to create a smoking area

Visual protection for unsightly surroundings like storage areas, clutter in the neighborhood, structural defects etc.

Protected seating area

Keeps a constant temperature of ambient air, especially in combination with heating radiators

Fixing of the side panel on the floor through customer

OPTIONAL

Connecting piece for joining the side panels of 2 parasols **6.3**

Available with roll-up door, door either on the right or left side (width: 130 cm)

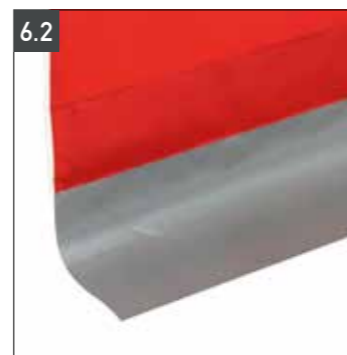

## 7 Impact Protection

Metal or soft padding? Some questions answer themselves when it comes to eliminating a potential source of injury (e.g. kindergartens or retirement homes).

Colorful soft foam safeguard; available in 10 colors

Cuff with soft foam on the inside

Outer material made of polyester fabric with PVC coating

With Velcro fasteners



## 8 Theft Protection and Authorized Use

You wouldn't park your high-end bicycle without locking it up first, right? Protect your parasol from theft with a lock that is incorporated in the installation option. Two additional cylindrical locks in the handles prevent unauthorized use (opening and closing) of the parasol.

**Lock in Handle** (included with delivery)

1 Cylindrical lock per handle

Prevention of unauthorized opening and closing

Easy to use

**Further Lock** (included with delivery)

Lock incorporated in the installation option

- theft protection **8.1**



# Additional Features



## 9 Lighting | LED Lighting

There are moments when time flies by. The sun was just shining and now twilight has set in. The »light« installed in the parasol creates a uniform and pleasant atmosphere, that turns the night into day and lets you forget the time.

Economical energy consumption, due to LED light bulbs or LED strips

All wiring is inside; no tangled cables

Appealing lighting condition extends outdoor season

Creates a warm and inviting atmosphere

Pleasant working atmosphere for service personnel

### Lighting

4 lamps on the center pole (LED light bulbs E14) **9.1**

Light temperature 2700 K

4 × 4 W light power

supply power 240 V  
(available in US edition - 120 V)

OPTIONAL

External control unit with FI-switch and on/off switch for each individual electromechanical option

### LED-Lighting

RGBW-LED strips **9.2**

Indirect RGBW-LED lighting 120-240/24V

Dimmable with remote control **9.3**

Integrated into parasol spokes

Color settings freely selectable by remote control and app (when using the APP a sufficient Wifi range must be ensured; suitable Wifi equipment is available from us), colors including warm white, cold white and neutral

OPTIONAL

2, 4, 6 or 8 RGBW-LED strips, model-related

External control unit with FI-switch and on/off switch for each individual electromechanical option

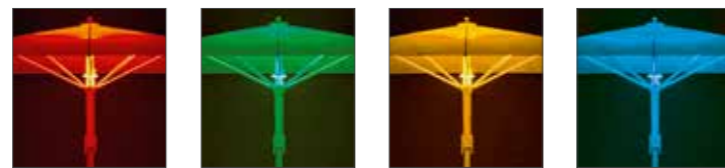

## 10 Heating

The »radiator« creates pleasant warmth by emitting infrared rays – without any pre-heating. When several are installed they can also be individually turned on or off. Even a cold ambient temperature is not perceived as unpleasant due to the direct warmth people feel. Use our heating option to defy frosty seasons and cool evenings.

Extended outdoor season; year-round outdoor living

2 or 4 electrical, infrared radiators

Remote control can regulate 6 levels

1500 watts per radiator

Long-lasting »Ultra Low Glow« heating tube

Can remain in closed parasol

OPTIONAL

External control unit with FI-switch and on/off switch for each individual electromechanical option

2 or 4 infrared radiators

## 11 Speakers

Music is much more than just an acoustical backdrop. An installed »audio system« can create very different atmospheres, in which people can have a lively celebration or simply relax after work – depending on desire and mood.

Audio system integrated into the frame

Optionally with one or two speakers

OPTIONAL

External control unit with FI-switch and on/off switch for each individual electromechanical option



## 12 TV

Who likes sitting alone at home in front of the TV? Especially not when everyone is outdoors watching the same thing. The additional feature »TV« gives outdoor screening a community spirit with a great deal of fun.

Stable, light-weight mount

Installation for 1 or 2 screens per parasol

### Frame Modification

Standard TV mounting console in parasol with VESA-Norm 200 for a maximum screen size of 32 inches

240 V power connection for 1 or 2 TVs on the mounting console (available in US edition - 120 V)

Network connection CAT 7 inside the electric crown unit

OPTIONAL

External control unit with FI-switch and on/off switch for each individual electromechanical option

## 13 Wifi

These days it already seems a matter of course that customers are offered free public Wifi. Installing a »Wifi Network« is not merely providing an additional service, it also attracts and keeps customers.

Only possible in combination with LED-Lighting option

Internal CAT7 wiring

Integrated CAT7 RJ45 network interface to be connected inside the in-ground installation

Internal power supply of the 24V DC router

Wifi Outdoor Access Point TP-Link EAP110 mounted onto center pole via weatherproof case

## 14 USB charging station

4 built-in USB sockets

for charging smartphones, notebooks etc.

Only possible in combination with lighting, 2/4 RGBW-LED strips and/or heating option



# Handling

Opening, tensioning and closing is quick and easy.

## OPENING

- Take off the safety strap. Lift the ends of the spokes until the parasol opens by itself.
- Latch in the spring buckle and press down on the handle. **1**

## CLOSING

- Lift handles up and unlatch the spring buckle.
- After completely closing the parasol (final position) Press handles down onto the pole (passive position).
- Pull the tips of the fabric to the outside of closed parasol and spirally wrap them around the center pole. **2**
- Wrap the safety strap around the parasol. **3**

The excellent appearance and the technical features of the textile membrane can be maintained by adhering to the following closing procedures:

Always pull the tips of the fabric to the outside of a closed parasol

Do not store the parasol with any fabric stuck between the spokes and support spokes

Spirally wrap the fabric around the center pole

Wrap the safety strap around the parasol to secure the fabric.

Re-adjust safety strap(s) in case of longer closing times

A protective cover is recommended

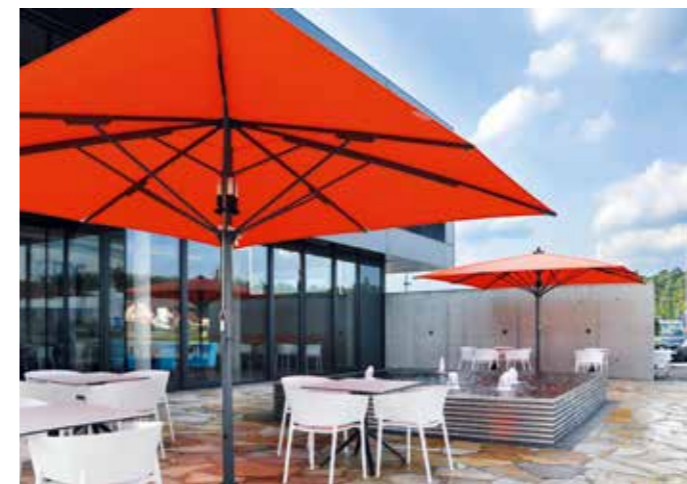
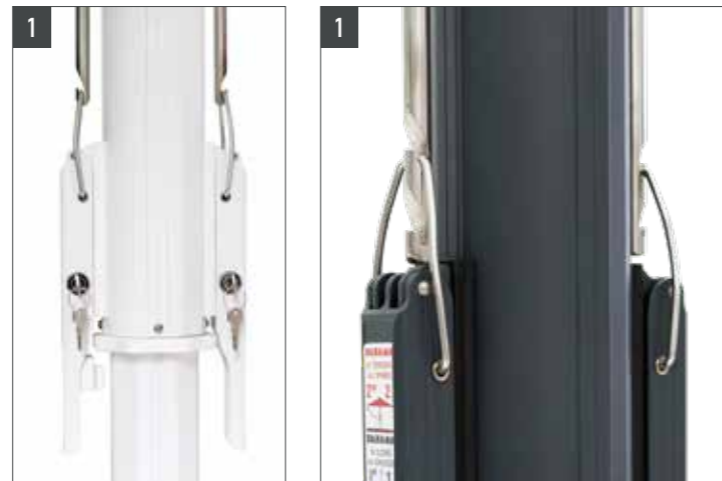

# Dimensions & Technical Data

## Jumbrella

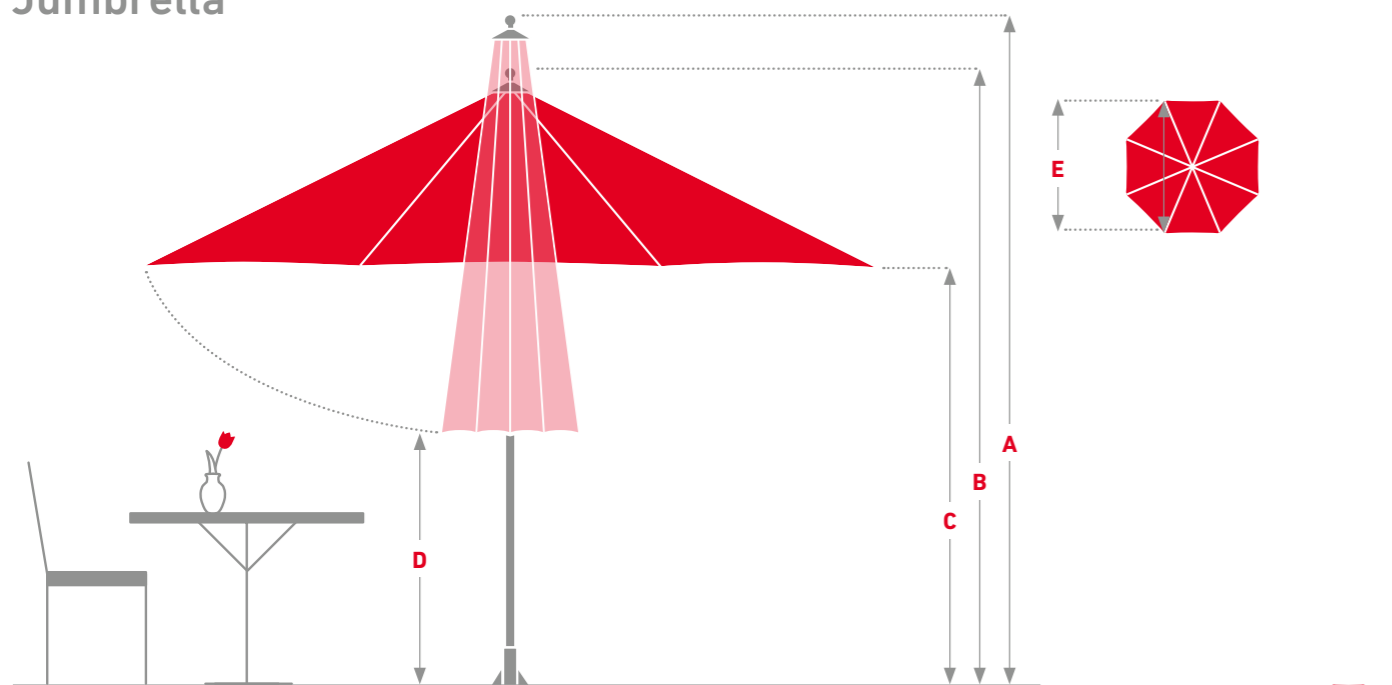

All measurements are approximate	Ø 3.0 m 8 Spokes	Ø 3.5 m 8 Spokes	Ø 4.0 m 8 Spokes	Ø 4.5 m 8 Spokes	Ø 5.0 m 8 Spokes	Ø 5.6 m 8 Spokes	Ø 6.3 m 8 Spokes	Ø 7.0 m 8 Spokes
Area in m <sup>2</sup>	7	9,6	12	15	19	24	29	36
Parasol weight Without installation component & packaging, in kg	30	32	35	40	54	65	72	99
Transport weight incl. packaging, in kg	50	52	55	60	74	85	97	124
<b>A</b> Height closed* in cm	381	391	375	385	385	387	426	446
<b>B</b> Height opened* in cm	310	318	302	311	311	316	352	372
<b>C</b> Passage height** in cm	230	228	230	230	227	227	245	253
<b>D</b> Ground clearance** in cm	231	193	135	140	120	90	95	85
<b>E</b> Inside circle dia. in cm	277	323	370	416	463	518	578	641
Max. permitted wind velocities fully opened parasol, km/h   Permanent/Mobile	102/77	95/71	95/71	95/71	88/66	74/56	48/36	38/29

All measurements are approximate	3.0 × 3.0 m 8 Spokes	3.5 × 3.5 m 8 Spokes	4.0 × 4.0 m 8 Spokes	4.5 × 4.5 m 8 Spokes	5.0 × 5.0 m 8 Spokes
Area in m <sup>2</sup>	9	12	16	20	25
Parasol weight Without installation component & packaging, in kg	39	43	50	57	84
Transport weight incl. packaging, in kg	59	63	70	77	109
<b>A</b> Height closed* in cm	375	385	375	385	401
<b>B</b> Height opened* in cm	301	311	311	311	331
<b>C</b> Passage height** in cm	230	226	230	230	240
<b>D</b> Ground clearance** in cm	150	119	80	54	38
Max. permitted wind velocities fully opened parasol, km/h   Permanent/Mobile	102/77	95/71	88/66	74/56	74/56

\* All measurements refer to the use with a permanent installation option (in-ground sleeve) \*\* For the edition with valance, the measurements reduce by 30 cm.

\*\*\* Available for order as of April 01, 2023.

the LARGE-SIZE parasol

Note: Subject to change without notice.

All measurements are approximate	3.0 × 1.5 m 8 Spokes	3.5 × 3.0 m*** 8 Spokes	4.0 × 2.0 m 8 Spokes	4.0 × 3.0 m 8 Spokes	4.0 × 3.5 m*** 8 Spokes
Area in m <sup>2</sup>	4.5	10.5	8	12	14
Parasol weight Without installation component & packaging, in kg	33	50	52	56	51
Transport weight incl. packaging, in kg	58	79	77	76	80
<b>A</b> Height closed* in cm	325	405	378	378	402
<b>B</b> Height opened* in cm	295	337	309	309	337
<b>C</b> Passage height** in cm	240	240	240	240	240
<b>D</b> Ground clearance** in cm	151	159	110	121	123
Max. permitted wind velocities fully opened parasol, km/h   Permanent/Mobile	95/71	88/66	88/66	88/66	88/66

All measurements are approximate	4.5 × 3.0 m 8 Spokes	4.5 × 3.5 m 8 Spokes	4.5 × 4.0 m*** 8 Spokes	5.0 × 2.5 m 8 Spokes	5.0 × 3.0 m 10 Spokes
Area in m <sup>2</sup>	13.5	15.75	18	12.5	15
Parasol weight Without installation component & packaging, in kg	55	56	52	57	58
Transport weight incl. packaging, in kg	80	81	81	82	83
<b>A</b> Height closed* in cm	424	424	401	393	424
<b>B</b> Height opened* in cm	338	338	336	323	322
<b>C</b> Passage height** in cm	240	240	240	240	240
<b>D</b> Ground clearance** in cm	139	126	87	95	93
Max. permitted wind velocities fully opened parasol, km/h   Permanent/Mobile	88/66	88/66	88/66	74/56	74/56

All measurements are approximate	5.0 × 3.75 m 10 Spokes	5.0 × 4.0 m 8 Spokes	6.0 × 3.0 m 10 Spokes	6.0 × 4.0 m 10 Spokes	6.0 × 4.5 m 12 Spokes
Area in m <sup>2</sup>	18.75	20	18	24	27
Parasol weight Without installation component & packaging, in kg	64	68	72	74	80
Transport weight incl. packaging, in kg	89	93	97	99	110
<b>A</b> Height closed* in cm	426	424	427	460	462
<b>B</b> Height opened* in cm	328	322	337	336	345
<b>C</b> Passage height** in cm	240	240	240	240	240
<b>D</b> Ground clearance** in cm	104	64	80	56	75
Max. permitted wind velocities fully opened parasol, km/h   Permanent/Mobile	74/56	74/56	50/38	50/38	50/38

Note: Subject to change without notice.

the LARGE-SIZE parasol





## Good to know

### Sustainability and Environmental Compatibility

The betex®05 fabric, exclusively crafted for Bahama, and the resulting textile membrane are certified exclusively according to the OEKO-TEX 100 standard, Class 1 which is awarded by independent institutions. Class 1 meets the demands of baby clothing with skin contact.

The OEKO-TEX pollutant test corresponds to the respective intended use of the textiles and materials. In Germany there are clear and reliable criteria for environmental compatibility and sustainability. Bahama demands of its products that every defect or damaged part can be replaced.

### Made in Germany

Bahama's customers always refer back to the great importance of our German production facilities. »Made in Germany« is still a unique selling point and a reason to buy. Bahama's full range production facility is located in Germany.

The combination of the highest quality materials and structural features allows Bahama to guarantee the wind stability of its products, depending on the model, up to 130 km/h. In addition to the technical details of the parasol, it is especially the lightfastness of the fabrics' colors, the water-proofness and grammage as well as the water column of the textile membranes which make Bahama top of its class. Trust is placed in Bahama by luxury hotels such as the Burj Al Arab in Dubai, the Hotel Sacher in Vienna and the Dalí Museum in St. Petersburg, USA.

### Service

Service greatly influences the life span of a parasol. The exchangeable textile membrane of a Bahama parasol can – after being exposed to all sorts of weather conditions for years – be cleaned or replaced. Our service makes a full technical and general overhaul of the product such that they not only look attractive, but can defy the strongest of winds.

No matter where you need Bahama's service, the Bahama team or one of our expert partners will be glad to help – worldwide.

---

Careful and individual planning

---

Installation of new parasols

---

Fitting of new textile membranes

---

Complete service i.e. assembling and disassembling the large parasols, washing, cleaning and maintenance of the frame and textile membranes

---

Membrane service, i.e. fitting and removing the textile membrane, cleaning and repairing

---

Storage of the returned and serviced large parasols and/or textile membranes

---

Technical trainings

---

### UV-Protection

Analogous to the sun protection factor/SPF all textiles are labeled with the ultraviolet protection factor/UPF. Built into the fabric it protects against hazardous UV radiation. Bahama uses the fabric brand betex®05 for the production of its parasol textile membranes. This material fulfills the requirements for UPF 50+, which indicates an »excellent« dermatological UV protection factor and allows less than one fiftieth (<2%) of the UV radiation through the textile membrane onto the skin.







01/2023

**BAHAMA®**